



KINETIK Shower Enclosures | K.D. Order Form



Fleurco Products inc • (514) 326 2222 • 1-800-993-0033 • Fax: (514) 326 2008 | www.kinetikhardware.com

Customer Name: _____

Date: _____

Contact Name: _____

Phone: _____

Email: _____

Ship To:

Sold To:

P.O. No. :	Customer No. :	Ship Via:	Confirmation Fax No. :

3 Sided | 2 Front Panels

Qty Ordered Polished Chrome Project: _____

Qty Ordered Stainless Steel Tag: _____

Dim A: Center to center of side threshold (inch)=

Dim B: Finished wall to center of front threshold (inch)=

Dim C: Unit Height (inch)=

Fabricator / Customer using Fleurco chart: **4A**

Return panel (inch)=

Door panel (inch)=

Fixed panel (inch)=

Note:

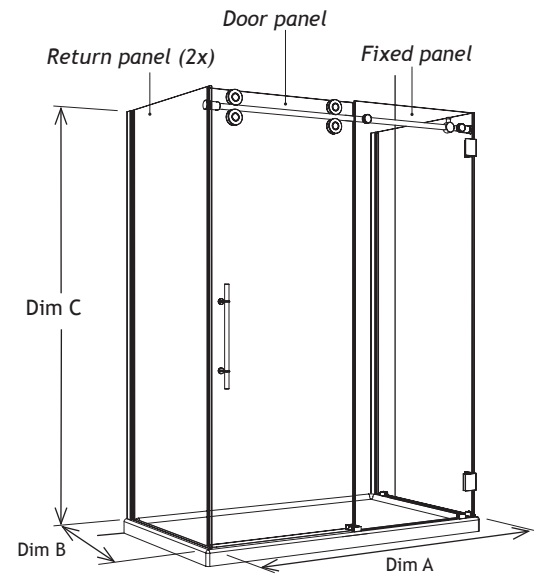

QTY	LIST PRICE	TOTAL	ITEM	FINISH	DESCRIPTION	Example	
						Quantity Required per unit above	
	\$1156			KTW160-35	Stainless Steel brushed	Running Rail (Length = Dim A - 1 3/8") (Price includes custom cutting & drilling)	1
	\$1256			KTW160-11	Polished		
	\$384 per set			KTWROLLER-35	Stainless Steel brushed	One set of double rollers	2 Sets
	\$424 per set			KTWROLLER-11	Polished		













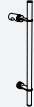

KINETIK Shower Enclosures | K.D. Order Form

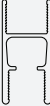

Fleurco Products inc • (514) 326 2222 • 1-800-993-0033 • Fax: (514) 326 2008 | www.kinetikhardware.com

3 Sided | 2 Front Panels

QTY	LIST PRICE	TOTAL	ITEM	FINISH	DESCRIPTION	Example	
						Quantity Required per unit above	
	\$100			KTWGB-35	Stainless Steel brushed	Return panel glass mount bracket	2
	\$100			KTWGB-11	Polished		
	\$96			KTWSTOPPER-35	Stainless Steel brushed	Door stopper	2
	\$108			KTWSTOPPER-11	Polished		
	\$58			KTWFASTENER-35	Stainless Steel brushed	Glass holder for fixed panel	2
	\$68			KTWFASTENER-11	Polished		
	\$78			ABN15415	Stainless Steel brushed	Bottom center guide	1
	\$78			AC15415	Polished		
	\$30			ABN15414	Stainless Steel brushed	Glass clip for bottom of fixed panel	5
	\$30			AC15414	Polished		
	\$170			HSTH25-10	Stainless Steel brushed	Straight handle 16"	1
	\$148			HSTH11-10	Polished		
	\$140			HCCL25-12	Stainless Steel brushed	90° Corner Glass Clip	2
	\$118			HCCL11-12	Polished		
	\$11/ft (Max: 8 ft)			ABN15417	Stainless Steel brushed	Expander (for 6,10,12mm glass)	2 pcs (Same as return panel height)
	\$16/ft (Max: 8 ft)			AC15417	Polished		
	\$8/ft (Max: 8 ft)			ABN15419	Stainless Steel brushed	Wall jamb	2 pcs (Return panel height + 3/16)
	\$7/ft (Max: 8 ft)			AC15419	Polished		
	\$5.50/ft (Max: 80")			HABN15405	Stainless Steel brushed	Threshold	3 pcs Dim A & Dim B (x2)
	\$4.25/ft (Max: 80")			HAC15405	Polished		
	\$4.00/ft (Max: 8 ft)			COEX K300	Clear	Door Panel Side Gasket	1 piece (Door height - 4 3/4")
	\$3.50/ft (Max: 8 ft)			COEX K100	Clear	Fixed Panel Side Gasket <i>(with double sided VHB adhesive tape)</i>	Same as door height
	\$3.75/ft (Max: 8 ft)			COEX K200	Clear	Door panel bottom gasket	Same as door panel width
	Sub-total						
	Discount						
	Total						

Approved by (Fleurco)

Signed (Customer)